

# XUKT1KSML2

Photoelectric sensors XU, XUKT, reflex, Sn 1.5 m, 12...24 VDC, cable 2 m



## Main

Range of product	Telemecanique Photoelectric sensors XU
Series name	Application packaging
Electronic sensor type	Photo-electric sensor
Sensor name	XUK
Sensor design	Compact 50 x 50
Detection system	Reflex
Material	Plastic
Type of output signal	Discrete
Supply circuit type	DC
Wiring technique	3-wire
Discrete output type	PNP or NPN
Discrete output function	1 NO or 1 NC programmable
Electrical connection	Cable
Cable length	2 m
Product specific application	Detection of transparent object
Emission	Red reflex
[Sn] nominal sensing distance	1.5 m reflex need reflector XUZC50

## Complementary

Enclosure material	PC
Lens material	PMMA
Output type	Solid state
Output function governance	Dark
Add on output	Without
Cable composition	2 x 0.34 mm <sup>2</sup>
Wire insulation material	PVC
Cable outer diameter	6 mm
Status LED	1 LED for output state
[Us] rated supply voltage	12...24 V DC with reverse polarity protection
Supply voltage limits	10...30 V AC/DC
Switching capacity in mA	<= 100 mA (overload and short-circuit protection)
Switching frequency	<= 1.5 kHz
Maximum voltage drop	<2 V (closed state)
Current consumption	<= 35 mA no-load
Time delay range	0.1...5 s monostable, on-delay or off-delay (programmable) delay
Maximum delay first up	80 ms
Maximum delay response	0.3 ms
Maximum delay recovery	0.3 ms
Setting-up	Sensitivity adjustment by potentiometer
Depth	50 mm
Height	50 mm
Width	18 mm
Net weight	0.035 kg
Kit composition	Bracket XULZ41 Sensor

The information provided in this documentation contains general descriptions and/or technical characteristics of the performance of the products contained herein. This documentation is not intended as a substitute for and is not to be used for determining suitability or reliability of these products for specific user applications. It is the duty of any such user or integrator to perform the appropriate and complete risk analysis, evaluation and testing of the products with respect to the relevant specific application or use thereof. Neither TWSS Holding nor any of its affiliates or subsidiaries shall be responsible or liable for misuse of the information contained herein.

## Environment

Product certifications	CE[RETURN]UL[RETURN]CSA
Ambient air temperature for operation	-25...55 °C
Ambient air temperature for storage	-40...70 °C
Vibration resistance	7 gn, amplitude = +/- 2 mm (f = 10...55 Hz) conforming to IEC 60068-2-6
Shock resistance	20 gn (duration = 11 ms) conforming to IEC 60068-2-27
IP degree of protection	IP65 conforming to IEC 60529 IP651 conforming to NF C 20-010

## Packing Units

Unit Type of Package 1	PCE
Number of Units in Package 1	1
Package 1 Height	4.2 cm
Package 1 Width	9.7 cm
Package 1 Length	13.2 cm
Package 1 Weight	254.0 g
Unit Type of Package 2	S02
Number of Units in Package 2	12
Package 2 Height	15 cm
Package 2 Width	30 cm
Package 2 Length	40 cm
Package 2 Weight	3.45 kg
Unit Type of Package 3	P06
Number of Units in Package 3	192
Package 3 Height	75 cm
Package 3 Width	40 cm
Package 3 Length	80 cm
Package 3 Weight	73.768 kg

## Offer Sustainability

Sustainable offer status	Green Premium product
California proposition 65	WARNING: This product can expose you to chemicals including: Diisononyl phthalate (DINP), which is known to the State of California to cause cancer, and Di-isodecyl phthalate (DIDP), which is known to the State of California to cause birth defects or other reproductive harm. For more information go to <a href="http://www.P65Warnings.ca.gov">www.P65Warnings.ca.gov</a>
For all Reach Rohs enquiries contact us at	<a href="mailto:sustainability@tesensors.com">sustainability@tesensors.com</a>

## Contractual warranty

Warranty	18 months
----------	-----------

Dimensions

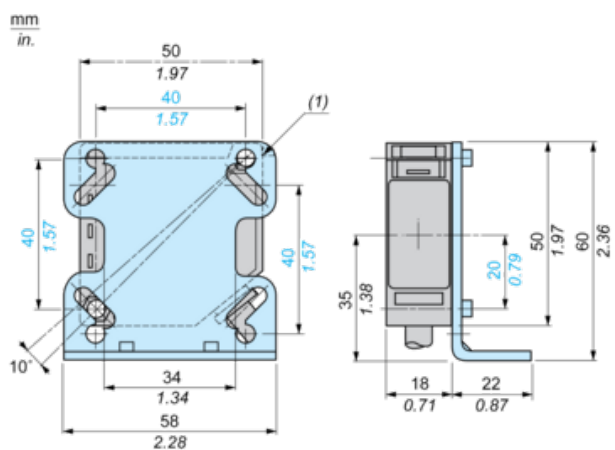

(1) Cover locking tongue

Bracket Fixing

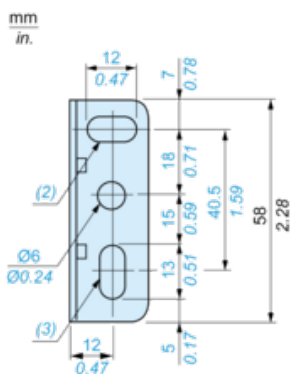

(2) 1 elongated hole Ø 6 x 12

(3) 1 elongated hole Ø 6 x 13

## Wiring Schemes

### Connector Scheme

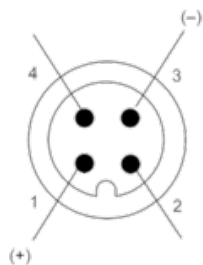

- 1 : (+)
- 2 : Alarm output
- 3 : (-)
- 4 : Output signal

### NC Programmed

PNP programmed output

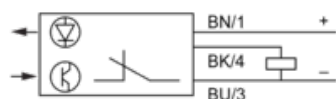

- BN : Brown
- BK : Black
- BU : Blue

NPN programmed output

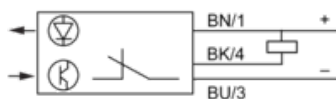

- BN : Brown
- BK : Black
- BU : Blue

### NO Programmed

PNP programmed output

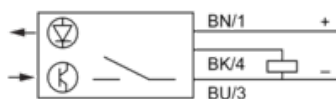

- BN : Brown
- BK : Black
- BU : Blue

NPN programmed output

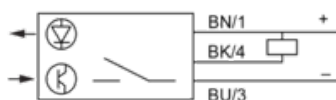

- BN : Brown
- BK : Black
- BU : Blue

### Alarm Output

PNP programmed

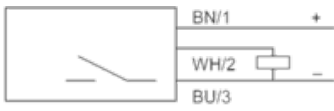

BN : Brown

WH : White

BU : Blue

NPN programmed



BN : Brown

WH : White

BU : Blue